

FROST *Fighters*

**DIRECT FIRED SPACE HEATERS
PROPANE AND NATURAL GAS**



**MODEL DF 400
MODEL DF 1500
OCTOBER 2009
TO PRESENT**

**Installation - Operation
Maintenance Instructions
and Parts List**

READ INSTRUCTIONS PRIOR TO STARTING HEATERS

ICE

ICE MANUFACTURING LTD.
51 AIKINS STREET
WINNIPEG, MANITOBA
CANADA R2W 4E3
TEL : (204) 586-8565
FAX: (204) 589-7682

ICE MANUFACTURING LTD.
100-1500 NOTRE DAME
WINNIPEG, MANITOBA
CANADA R3P 0E9
TEL : (204) 775-8252
FAX: (204) 783-6794
TOLL FREE: (888) 792-0374



Intertek

OCTOBER, 2009

WWW.FROST-FIGHTER.COM

FROSTFIGHTER WARRANTY

I.C.E. Mfg. Ltd. warrants the Frostfighter heater to be free from defects in workmanship and materials for a period of twelve (12) months from date of initial service not to exceed fifteen (15) months from date of shipment.

If during the warranty period, the heat exchanger fails under normal use and service due to a defect in material or workmanship said heat exchanger will be repaired or replace free of charge F.O.B. the Winnipeg Factory..

All mechanical and electrical components are covered by a one (1) year limited warranty. Normal maintenance items are excluded under the warranty. The warranty does NOT include any freight, labor or sales taxes incurred by the purchaser and is subject to the following conditions:

1. The heater shall be operated in accordance with the manufacturer's operating and maintenance manual.
2. The heater shall be subject to normal use in service and shall not have been misused, neglected, altered or other wise damaged.
3. The unit shall be operated within the rated capacities and with the prescribed fuel.
4. The unit has not been allowed to exceed its proper temperature limits due to control malfunction or inadequate air circulation.
5. There is no evidence that the unit has been subject to tampering or deliberate destruction.

No representative of I.C.E. Mfg. Ltd., nor any of its distributors or dealers, is authorized to assume for I.C.E. Mfg. Ltd. any other obligations or liability in connection with this product, not alter the terms of the warranty in any way. This warranty is limited to the express provisions contained herein and does not extend to liability for labor costs incurred in replacing defective parts.

Parts can be obtained from I.C.E. Mfg. Ltd., Winnipeg, Manitoba on the basis that credit will be issued if the defective parts returned qualify for replacement pursuant to the terms and conditions of this warranty. Authorization to return any alleged defective parts must be first obtained from the factory prior to transporting the part. The transportation charges for the alleged defective part must be prepaid by the owner. I.C.E. Mfg. Ltd. will not accept charges for parts purchased unless the conditions of this warranty have been satisfied and prior authorization to purchase the parts has been received from the factory.



100-1500 NOTRE DAME , WINNIPEG, MANITOBA
R3P 0E9, (204) 775-8252, 1-888-792-0374

**INSTALLATION- OPERATION
MAINTENANCE INSTRUCTIONS**

READ INSTRUCTIONS PRIOR TO OPERATING HEATER

GENERAL HAZARD WARNING

FAILURE TO COMPLY WITH PRECAUTIONS AND INSTRUCTIONS PROVIDED WITH THIS HEATER CAN RESULT IN DEATH, SERIOUS BODILY INJURY AND PROPERTY LOSS OR DAMAGE FROM HAZARDS OF FIRE, EXPLOSION, BURN, ASPHYXIATION, CARBON MONOXIDE POISONING, AND/OR ELECTRICAL SHOCK.

ONLY PERSONS WHO CAN UNDERSTAND AND FOLLOW THE INSTRUCTIONS SHOULD USE OR SERVICE THIS HEATING UNIT.

IF YOU REQUIRE ASSISTANCE OR HEATER INFORMATION SUCH AS AN INSTRUCTION MANUAL, LABELS, ETC., CONTACT THE MANUFACTURER.

WARNING

FIRE, BURN INHALATION, AND EXPLOSION HAZARD. KEEP SOLID COMBUSTIBLES, SUCH AS BUILDING MATERIAL, PAPER AND/OR CARDBOARD A SAFE DISTANCE AWAY FROM THE HEATER AS RECOMMENDED BY THE INSTRUCTIONS. NEVER USE THE HEATER IN SPACES WHICH MAY CONTAIN VOLATILE OR AIRBORNE COMBUSTIBLES, OR PRODUCTS SUCH AS GASOLINE, SOLVENTS, PAINT THINNER, ACETONE, DUST PARTICLES AND/OR UNKNOWN CHEMICALS.

WARNING

THIS PRODUCT IS NOT INTENDED FOR HOME OR RECREATIONAL VEHICLE USE.

FOR YOUR SAFETY

DO NOT USE THIS HEATER IN A SPACE WHERE GASOLINE OR OTHER LIQUIDS HAVING FLAMMABLE VAPOURS ARE STORED OR USED.

GENERAL NOTES:

NATURAL GAS CODE: B149.1
PROPANE GAS CODE: B149.2

ALL GAS INSPECTION AUTHORITIES IN CANADA REQUIRE THAT THE INSTALLATION AND MAINTENANCE OF HEATER AND ACCESSORIES SHALL BE ACCOMPLISHED BY A QUALIFIED GAS FITTER.

THE INTENDED USE OF THIS HEATER IS FOR THE TEMPORARY HEATING OF BUILDINGS OR STRUCTURES UNDER CONSTRUCTION, ALTERATION OR REPAIR.

SPECIFICATIONS

The heaters are designed and approved for use as gas fired unvented construction heaters under applicable requirements of ANSI Z83.7 and CGA 2.14.

MODEL	DF-400	DF-1500
Heat Capacity	400,000 Btu/hr	1,500,000 Btu/hr
Fuel	Natural or Propane	Natural or Propane
Fan Motor	½ Hp 1750 RPM	1 Hp 1750 RPM
Air Capacity	2500 cfm	7700cfm
Manifold Pressure	LP=1.4 NG=3.5	LP=1.5 NG=3.6
Minimum Inlet Pressure	7.0" w.c.	7.0" w.c.
Maximum Inlet Pressure	14.0" w.c.	14.0" w.c.
Minimum Temp Rating	-40°C/°F	-40°C/°F
Fuel Consumption Propane	157 CFH 4.5USGPH	589 CFH 16.8 USGPH
Fuel Consumption Natural	390 CFH	1461 CFH
Approval Agency	ETL	ETL
Overall Dimensions Crated	30 1/2"W" 51"L 33"H	39 1/2" W 74 1/4" L 52 1/2" H
Weight	145 lbs.	360 lbs.
Electrical	120 V 15 amps	120 V 20 amps

COMMON INSTALLATION AND OPERATING PROBLEMS

1. LOW VOLTAGE: (MOST COMMON PROBLEM)
 - Wire guage for supply cord is too small. If guage is too small, low voltage can result, with the motor over heating, burnt relay contacts, or a relay that will not maintain contact.
2. Gas supply line is too small.
3. Improper gas supply pressure.(ensure gas supply connected to correct union as per operating instructions.)
4. Insufficient vaporization at supply (propane unit).
 - Normally caused by too small size of tank, or in cold conditions operating without a vaporizer.
5. Dirty gas supply.
6. Lack of preventative maintenance-burner parts and fan blades must be cleaned as required, especially when used in a dirty environment
7. Improper supply of fresh air.-in an enclosed area, intake air should be from outside. This slight pressurization, prevents problems associated with recirculation.

GENERAL NOTES:

1. The heater is designed and approved for use as a construction heater under ANSI Z83.7 and under CGA 2.14.
2. ICE cannot anticipate every use, which may be made of our heaters. CHECK WITH YOUR LOCAL FIRE AND SAFETY AUTHORITY IF YOU HAVE QUESTIONS ABOUT SAFE APPLICATIONS.
3. Other standards govern the use of fuel gases and heat producing products in specific applications. Your local authority can advise you about this issue.
4. Please retain this instruction manual for future reference.
5. The primary application of this heater is for temporary heating of construction sites and/or applications of this type.
6. Check Rating Plate on heater for set up specifications.
7. For information about replacement parts call toll free 1-888-792-0374

ELECTRICAL NOTES:

1. All electrical connections and grounding shall be in compliance with the National Electrical Code, ANSI/NFPA70 and/or the Canadian Electrical Code (CSA Standard C22.1-98).
2. WARNING: Electrical grounding instructions... This appliance is equipped with a three prong (grounding) plug for your added protection against electrical shock hazard and should be plugged directly into a properly grounded three-prong receptacle.

INSTALLATION INSTRUCTIONS:

1. The National Fuel Code, ANSI 223.1/NFPA 54 and/or National Gas and Propane Installation Code CSA B149.1 installation codes must be followed as well as the recommendations of local authorities having jurisdiction.
2. Inspect the heater before each use and have it annually inspected by a qualified agency.
3. The hose assembly shall be visually inspected prior to each use of the heater. If it is evident there is excessive abrasion or wear, or the hose is cut, it must be replaced prior to the heater being put into operation. The replacement hose assembly shall be specified by the manufacturer. The hose assembly shall be protected from traffic, building materials and contact with hot surfaces both during use and while in storage.
4. When firing the unit in an enclosed area, three square feet (0.278 square meters), must be provided to allow free entry of the air required for operation.
5. Do not operate the unit in areas that do not have proper ventilation.
6. Do not obstruct the flow of combustion and ventilation air through the unit.
7. Do not operate the unit in close proximity to combustible surfaces, materials, gasoline, and other flammable vapours and liquids.
8. When connecting the heater to a natural gas or propane supply line ensure that the pressure at the heater inlet is within the specified range. Excessive pressure will damage the controls and void the warranty. See page 13 for gas hook up and inlet pressures.
9. After installation, check the manifold assembly for gas leaks by applying a water and soap solution to each connection.
10. Connect the heater to an adequate 115-volt electrical supply as specified on the rating plate. For protection against shock hazard the supply cord must be plugged into a properly grounded three-prong receptacle.
11. In all applications, install the heater in such a manner that it is not directly exposed to water spray, rain and/or dripping water



12. Ensure the unit is installed on a level surface

ADDITIONAL INSTRUCTIONS FOR PROPANE GAS:

13. The installation must conform with local codes or, in the absence of local codes, with the Standard for the *Storage and Handling of Liquefied petroleum Gases, ANSI/NFPA 58* and the *Natural Gas and Propane Installation Code, CSAB149.1*
14. The heater must be located more than ten (10) feet (3 meters) away from the propane source or propane tank.
15. The heater must not be directed toward any propane gas container within 20 feet (6.1 meters).
16. Ensure that the size and capacity of the propane supply container is adequate to provide the rated Btu/h input for the surrounding temperature.



17. **IT IS DANGEROUS TO SUPPLY LIQUID PROPANE TO THE HEATER.** Arrange the propane supply system to provide for vapour withdrawal from the operating source.

18. The connection and disconnection of the propane source must conform with CAN/CGA B149.2 Propane Installation Code and any applicable local codes. Refer to the Gas Leakage Test section of this manual for leak testing procedures.

19. When the heater is not in use insure to shut off the gas supply from the propane source or propane tank.

20. Minimum LP tank capacity is as follows:

DF 400	300 pounds
DF 1500	500 gallon tank

21. The unit has a 3/4" NPT pipe union (Df400) or a 1 1/4" NPT pipe union (Df1500) for the fuel line connection. Connect/disconnect the union to supply/remove the fuel source.

22. When the heater is to be stored indoors, the connection between the propane supply cylinder(s) and the heater must be disconnected and the cylinder(s) removed from the heater and stored in accordance with the Standard for the *Storage and Handling of Liquefied Petroleum Gases*, ANSI/NFPA58 and CSA B149.1, *Natural Gas and Propane Installation Code*.

CLEANING INSTRUCTIONS:

1. The unit should be cleaned externally with soap and water.
2. Ensure that the electrical control box is closed before cleaning unit.
3. Ensure that the power cord is disconnected before cleaning.
4. Ensure that the fuel supply is off and disconnected before cleaning.

INSTALLATION CLEARANCES FROM COMBUSTIBLES:

Front Outlet = 20 Feet (6M)

Intake = 2 Feet (0.6M)

Sides = 2 Feet (0.6M)

Top = 4 Feet (1.2M)

CAUTION

1. The electrical box must be closed to ensure operator(s) safety when operating the unit.
2. Do not shut off unit by disconnecting supply cord. Turn gas off, wait for unit to shut off automatically. Then flip toggle switch to off position. Disconnect power supply cord from outlet.
3. The gas supply line length cannot be less than 15 feet (4.6 meters) and not greater than 25 feet (8 meters).

OPERATING INSTRUCTIONS

1. Turn off main gas firing valve (yellow handle).
2. Check that the supply gas and conversion valves are set to the same gas type.
3. Once valve setting is verified, turn on main gas firing valves to open position.
- 4 Check that the operating switch on the unit is in the "OFF" position before plugging supply cord to a 115 VAC outlet.
5. Plug power supply cord to a 115 VAC outlet.
6. Flip toggle switch to either manual or thermostat position.
7. If thermostat position ,set thermostat to desired temperature.
8. To stop heater, turn off gas, wait for unit to shut off automatically. Then flip toggle switch to off position. Disconnect power supply cord from outlet.

***IF HEATER FAILS TO START, REFER TO TROUBLE SHOOTING GUIDE**

SEQUENCE OF OPERATION DF400

1. Flip toggle switch to either manual or thermostat position.
2. The supply fan starts immediately.
3. When the fan starts, the air proving switch will close and through the high limit will power up the ignition controller.
4. The ignition controller will flash red for one second then will pre-purge for five seconds. Then the gas valve will be energized, the ignitor will spark for four seconds and the burner on light will come on. The flame failure light is on during the purge period.
5. When the flame is detected, spark will shut off.
6. Unit will run till call for heat is satisfied, either through thermostat or turning toggle switch to off position.

****IF HEATER FAILS TO START REFER TO TROUBLESHOOTING GUIDE****

The sequence for the DF1500 is the same as above except for a two stage firing system (low and high fire)

7. When the toggle switch is placed in the high fire position, a gas valve delay timer is energized. This will provide a 15 second delay before unit goes to high fire so as not to have too much gas going into the burner upon ignition. DF-1500 operates at either low fire or high fire by the position of the toggle switch.

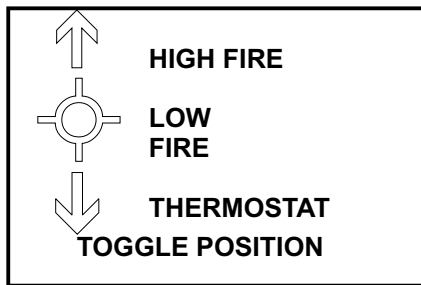

Manual-Low Fire

Manual-High Fire

Manual-Thermostat

Thermostat-Low fire

Thermostat-High Fire

Thermostat-Thermostat

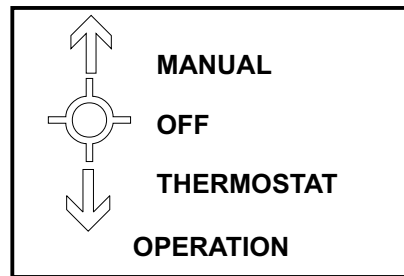

Unit will run only on low fire

Unit will run on low fire for 15 seconds, then goes to and remains on high fire.

Unit will run on high fire till call for heat is satisfied. Unit will then go to and remain on low fire

Unit will run on low fire until call for heat is satisfied then unit will shut off.

Unit will run on high fire until call for heat satisfied then unit will shut off.

Unit will run on high fire until temperature rises to within 3 degrees F of set temperature on thermostat. It will then go to low fire until reaching set temperature, then the unit will shut down.



STANDARD GAS CONVERSION PROCEDURE

CHECK TYPE OF GAS BEING USED FOR OPERATION. SUITABLE GASES ARE NATURAL GAS AND PROPANE GAS.

Propane Gas

1. For propane gas use, the conversion valve must be placed in the propane gas position as per the label on the unit. This is the closed position of the red handled ball valve on the manifold. Handle should be 90° to the valve.

2. Once in the closed position, the valve must be locked in that position so that the unit will operate safely.

Natural Gas

1. For natural gas use, the conversion valve must be placed in the natural gas position as per the label on the unit. This is the open or parallel position to the manifold. Red handled ball valve must be in line with the manifold.

2. Once placed in the open position, double check that you are using natural gas. Propane used in this open position could present a hazardous situation.

DF MAINTENANCE INSTRUCTIONS.

!WARNING!: Maintenance should be performed by trained personnel only. Incorrect maintenance may result in improper operation and serious injury. The unit should be inspected before each use and at least annually.

All components should be regularly checked as follows:

High Limit Switch

The high limit switch should be checked to ensure the burner will shutdown if supply air temperature exceeds 220°F. This can be done by placing an operating unit behind the test unit so its discharge air is drawn into the supply air of test unit.

Gas Valve Delay Timer (DF1500)

This timer should be regularly checked to ensure proper high fire operation. To do this, turn unit onto MANUAL-HIGH FIRE. After 15 seconds, unit should go from low to high fire.

Air Proving Switch

Remove 1/4" aluminum tubing from inside chamber (behind fan blade) and blow out with air pressure to ensure no obstructions are inside tube. Replace tube, then with a minimum of 12" X 12" piece of cardboard, place at the top center of the end plate screen. Start unit with gas off. The unit should run for 15 seconds without the burner on light coming on, or the ignition controller LED light flashing then shut off. If the blower on light does come on, replace air switch.

Ignition Controller

With gas off, start machine. Red light on controller should flash for 1 second then stay off. After 5 seconds, ignitor should spark for 4 seconds, then red light should flash 3 times then unit will shut down. With gas on, start unit. Once flame is proven, turn off yellow handled ball valve. Once controller senses flame loss, it should try for ignition (spark) for 4 seconds, then flash red 3 times to indicate flame failure.

Flame Current Check Single Spark and Sense

To measure flame current, disconnect the input voltage, and attach the leads from the multimeter with a DC microampere scale to FC+ and FC-terminals to the 35-70 flame sense test pins found on the Fenwal ignition controller. Reconnect the input voltage and initiate the call for heat. After sparking is complete and the flame is established, the meter should read 1.0 DC microamperes or higher. If meter reads below "0" on the scale, meter leads are reversed. Disconnect power and reconnect meter leads for proper polarity.

Motor

To prevent motor overheating, ensure motor is clean and free of dust and dirt.

Thermostat

Check thermostat by turning unit to thermostat mode, unit should start and stop according to call for heat from stat.

Spark plug

Should be checked regularly to ensure a good spark. Set gap at 1/16".

Manifold-Gas leak testing

After removal for service or replacing components on the gas manifold, a gas leak test must be performed.

1. Close main gas firing valve on the gas manifold.
2. Connect your source of gas to the gas manifold.
3. Once connections are tightened, open source gas. Start unit
4. On each connection and fitting apply soap solution and check for bubbles. This will indicate a gas leak if bubbles continue to form.
5. Fix any leaks that are found by applying pipe dope to the leaking fitting or connection and re-tighten. Check for leaks once repairs, if any, are made.
6. Open main gas firing valve and start the unit.
7. Once the unit is operating and the burner is running, redo the soap test to ensure gas fittings are tight.
8. Fix any leaks found.

ROUTINE MAINTENANCE**1. VISUAL CHECKS:**

- Wheels, check to ensure bolts are tight
- Heater shell, control box and heat shield
- End plate with screen, ensure all holding screws are in place
- Frame, no major dents or cracked welds

2. BURNER MAINTENANCE:

- Igniter/sensor = Clean with soft wire brush, or solvent and check gap.
- Igniter wire = Check for cracked insulation and ends to ensure a good connection.
- Ground wire = Ensure ground wire is secured to the metal housing, as this is necessary for the flame detection system to operate.

3. CONTROL BOX:

- Inside the control box should be cleaned using a dry cloth or by blowing compressed air.
- Do not use any liquid or aerosol spray cleaners.
- Check that all electrical connections are snug and tight.

4. ELECTRICAL

- Plug in cord, open cord and check all connections, make sure tight and no frayed wires exposed
- Check conduit, make sure all BX connectors are tight.

5. FAN:

- Check for dust or dirt build up on fan blades.
- Check the tightness of the set screw.
- Run the heater to check for fan vibration
(replace fan blade if vibrations are noticeable)

SAFETY FEATURES

1. LOSS OF FLAME:

- Gas supply will shut down if flame is lost to prevent raw gas from leaving the heater.

2. OVERHEATING:

- Thermal overload protection in motor.
- High limit switch to prevent unit from over heating.

3. LOSS OF POWER:

- If a safety feature is damaged/ wired incorrectly, the unit will shutdown.
- Unit will require manual reset if insufficient power or incorrect gauge of wire.

4. BLOCKED AIR SUPPLY:

- The air proving switch detects air flow
- If there is low or no air flow the burner will not fire.

5. FLAME FAILURE LIGHT:

- Safety red light will come on in case of flame failure





DF TROUBLE SHOOTING GUIDE

**ALWAYS DOUBLE CHECK FOR SUFFICIENT POWER AND GAUGE OF CORD,
POLARITY AND GAS PRESSURE**

1. Unit will not start.

- *Check for 115 volts AC across terminals 1 and 2. If no voltage check power source.
- *Check 15 amp circuit breaker. Reset if required..
- *Check for power on terminal 3. If no power, check toggle switch or thermostat to ensure they are working properly.
- *Check wiring on motor, if wired correctly, and has 110V coming in, replace motor.

2. Burner will not ignite.

- *Check polarity.
- *Make sure conversion valve is in proper position for gas being used.
- *Ensure you have proper gas pressure coming into machine. Please refer to page 13.
- *Ensure that the air inlet is not blocked.
- *Light on ignition controller should blink red once on start up.
- *Remove red L1 wire from ignition controller. Check for power during trial for ignition (4 seconds). If none, check high limit and replace if necessary.
- *Check for 115V across V1 and V2 on ignition controller during trial for ignition. Check neutral line, L2, and grounds are tight. If OK, then replace ignition controller if no power at V1 and V2.
- *Solenoid valve should click at start of ignition. Check for gas pressure at 1/8" tap on elbow before burner. If no pressure, replace solenoid or 2 stage valve.
- *Check that spark plug is properly connected to ignition wire and is not cracked or chipped. Gap is 1/16" check ignition wire is not damaged. Ensure spark plug is screwed all the way in and is fairly tight.
-  *Check air switch. During trial for ignition (4seconds) check for power on terminal 4 and on terminal 5. If there is no power on terminal 5 and not on terminal 6 the air switch tubing is blocked or the air switch is faulty
- 
- 
- 

3. Burner ignites but then stops.

- *Check ignition wire connections, check spark plug and ignition wire for damage.
- *Check polarity.
- *Ensure ignition controller is receiving 1.0 DC microampere signal. (Refer to maintenance on flame current check.) If signal at controller replace controller. No signal check spark plug and wire.

4. Flames extend out of the unit.

- *Check that the LP/NG (red handle) valve is in the proper position for the fuel that is being used.
- *Check that the manifold pressure is at the proper setting.

The following apply only to DF1500 units.
Heater does not cycle from low to high flame

- *Check thermostat to ensure wires tight and working properly.
- *Check black wire going into gas valve delay timer for 115V. If no power while thermostat set at temperature at least 5 degrees higher than room temperature, replace thermostat.
- *If no power on black wire (#3) on top of timer, replace timer.
- *On high fire toggle power should be on both sides of yellow wire on timer. If none on bottom (#8) check R2 relay and open contacts. If no power on top, replace timer.
- *Check MV connection at 2 stage gas valve for power (across MV and PV/MV) if power present replace gas valve.
- *Ensure you have unit hooked up properly for gas supply pressure (see Operating Instructions) and sufficient minimum gas pressure.

**11 Inches w.c. Operating Pressure
Nominal Pipe Size of Schedule 40 Pipe for Propane
Last Stage Regulator Set at 11 Inches w.c.**

Maximum Load in Thousands of Btuh	Distance in ft from Last Stage Regulator to Burner														
	10	15	20	25	30	40	50	60	80	100	150	200	250	300	
37	3/8	3/8	3/8	3/8	3/8	3/8	3/8	3/8	3/8	3/8	3/8	1/2	1/2	1/2	
50	3/8	3/8	3/8	3/8	3/8	3/8	3/8	3/8	3/8	1/2	1/2	1/2	1/2	3/4	
62	3/8	3/8	3/8	3/8	3/8	3/8	3/8	1/2	1/2	1/2	1/2	3/4	3/4	3/4	
75	3/8	3/8	3/8	3/8	3/8	1/2	1/2	1/2	1/2	1/2	3/4	3/4	3/4	3/4	
100	3/8	3/8	3/8	1/2	1/2	1/2	1/2	1/2	3/4	3/4	3/4	3/4	3/4	3/4	
125	3/8	1/2	1/2	1/2	1/2	1/2	3/8	3/4	3/4	3/4	3/4	1	1	1	
150	1/2	1/2	1/2	1/2	1/2	3/4	3/4	3/4	3/4	3/4	3/4	1	1	1	
175	1/2	1/2	1/2	3/4	3/4	3/4	3/4	3/4	3/4	3/4	3/4	1	1	1	
200	1/2	1/2	3/4	3/4	3/4	3/4	3/4	3/4	1	1	1	1	1	1 1/4	
250	1/2	3/4	3/4	3/4	3/4	3/4	3/4	1	1	1	1	1 1/4	1 1/4	1 1/4	
300	3/4	3/4	3/4	3/4	3/4	1	1	1	1	1	1 1/4	1 1/4	1 1/4	1 1/4	
350	3/4	3/4	3/4	3/4	1	1	1	1	1	1 1/4	1 1/4	1 1/4	1 1/4	1 1/4	
400	3/4	3/4	1	1	1	1	1	1	1 1/4	1 1/4	1 1/4	1 1/4	1 1/4	1 1/2	
450	3/4	3/4	1	1	1	1	1	1 1/4	1 1/4	1 1/4	1 1/4	1 1/4	1 1/2	1 1/2	
500	3/4	1	1	1	1	1	1 1/4	1 1/4	1 1/4	1 1/4	1 1/4	1 1/2	1 1/2	1 1/2	
625	1	1	1	1	1 1/4	1 1/4	1 1/4	1 1/4	1 1/4	1 1/4	1 1/2	1 1/2	1 1/2	2	
750	1	1	1 1/4	1 1/4	1 1/4	1 1/4	1 1/4	1 1/4	1 1/4	1 1/2	1 1/2	2	2	2	
875	1	1 1/4	1 1/4	1 1/4	1 1/4	1 1/4	1 1/4	1 1/2	1 1/2	1 1/2	2	2	2	2	
1,000	1	1 1/4	1 1/4	1 1/4	1 1/4	1 1/4	1 1/2	1 1/2	1 1/2	1 1/2	2	2	2	2	
1,125	1 1/4	1 1/4	1 1/4	1 1/4	1 1/4	1 1/2	1 1/2	1 1/2	1 1/2	2	2	2	2	2 1/2	
1,250	1 1/4	1 1/4	1 1/4	1 1/4	1 1/2	1 1/2	1 1/2	1 1/2	2	2	2	2	2 1/2	2 1/2	
1,500	1 1/4	1 1/4	1 1/4	1 1/2	1 1/2	1 1/2	2	2	2	2	2	2 1/2	2 1/2	2 1/2	
1,750	1 1/4	1 1/2	1 1/2	1 1/2	1 1/2	2	2	2	2	2	2 1/2	2 1/2	2 1/2	2 1/2	
2,000	1 1/4	1 1/2	1 1/2	1 1/2	2	2	2	2	2	2 1/2	2 1/2	2 1/2	3	3	
2,250	1 1/2	1 1/2	1 1/2	2	2	2	2	2	2 1/2	2 1/2	2 1/2	3	3	3	
2,500	1 1/2	1 1/2	2	2	2	2	2	2	2 1/2	2 1/2	2 1/2	3	3	3	
2,750	1 1/2	2	2	2	2	2	2 1/2	2 1/2	2 1/2	2 1/2	3	3	3	3	
3,000	1 1/2	2	2	2	2	2	2 1/2	2 1/2	2 1/2	2 1/2	3	3	3	3	

DF 1500 Wiring Panel

1	Fenwal Ignition Module	60139A	8	Terminal Strip	60221
2	High Limit Switch	48110A	9	Air Tube w/Bracket	60222
3	Air Switch	48294	10	Timer Base	60822A
4	15 Amp Circuit Breaker	48216	11	30 Sec Timer	60822
5	3 Way Toggle Switch	48160	*12	2 Stage Thermostat	47301A
6	Green 120V Light	48006	13	Ignition Wire	50140A
7	Red 120V Light	48005	* Mounted on side of control box		

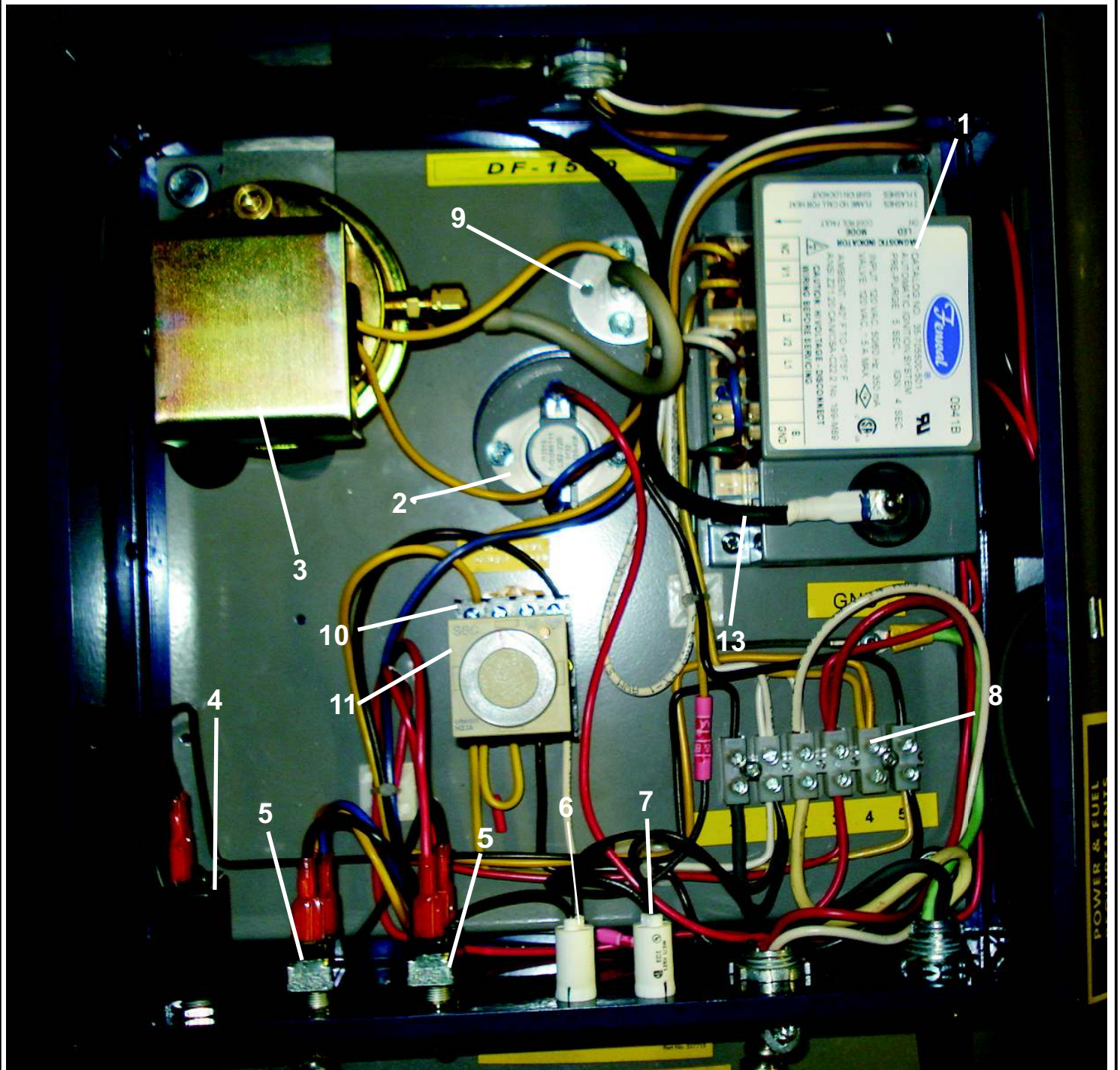

DF 400 WIRING PANEL

1	Fenwal Ignition Module	60139A	8	Terminal Strip	60221
2	High Limit	48110A	9	Air tube w/bracket	60222
3	Air Switch	48294	10	Thermostat*	47301
4	15 Amp Circuit Breaker	48216	11	Ignition wire	50140
5	3 Way Toggle Switch	48160			
6	Green 120V Light	48006			
7	Red 120V Light	48005			

* Mounted on exterior of control box

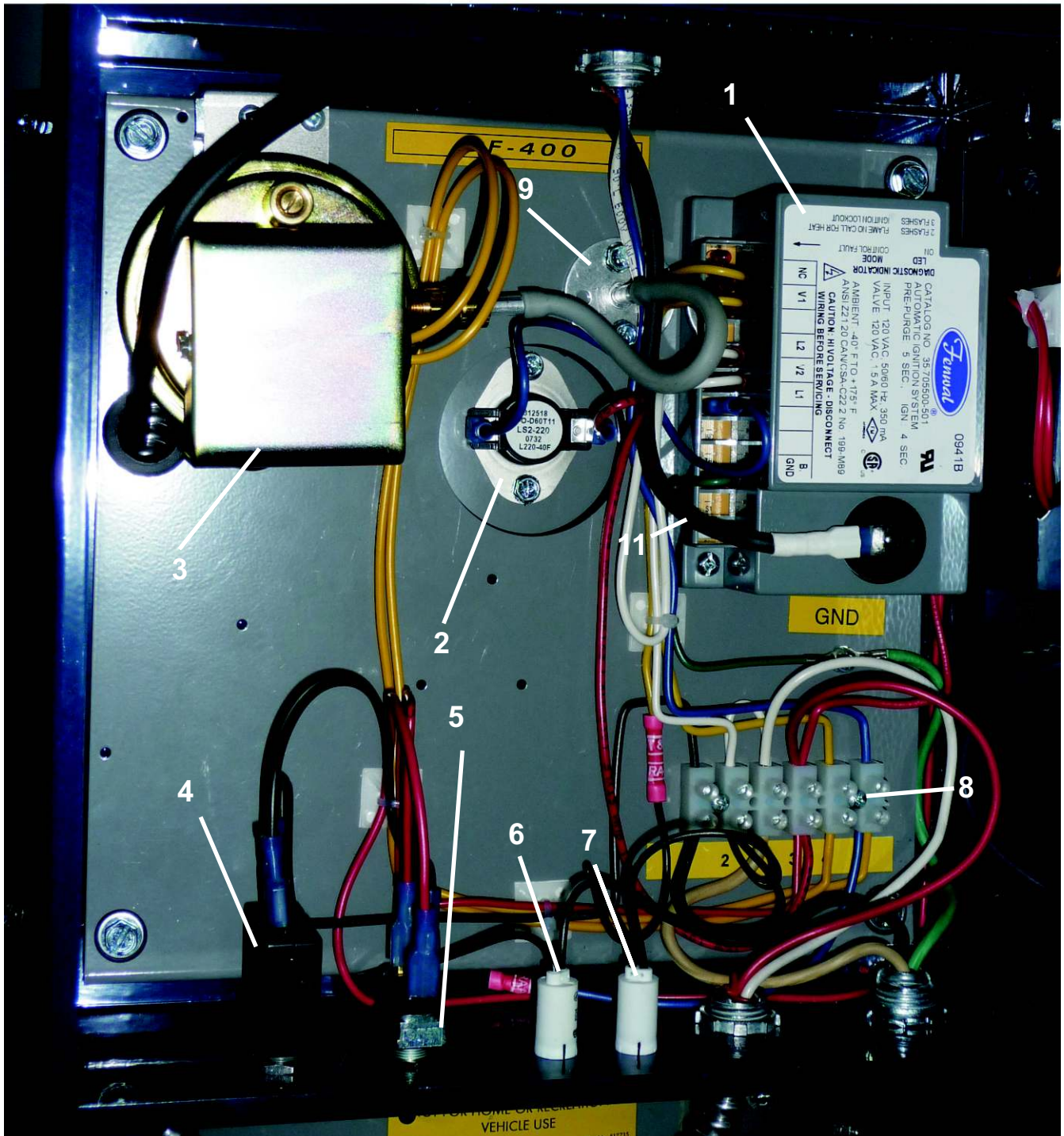

Manifolds

DF 400

- | | | | | | |
|---|--------------------------|--------|---|-----------------|--------|
| 1 | Conversion Valve | 50271 | 5 | 10lbs regulator | 50275A |
| 2 | 3/4" shut off ball valve | 50270 | | | |
| 3 | 3/4" solenoid valve | 50277A | | | |
| 4 | RV53 Regulator | 50274 | | | |

IF GAS SUPPLY IS OVER 1/2 PSI (14" WATER COLUMN) CONNECT TO UNION A ON MANIFOLD. IF GAS PRESSURE IS 1/2PSI OR LESS, REMOVE THE 10LBS REGULATOR AND CONNECT TO UNION B.

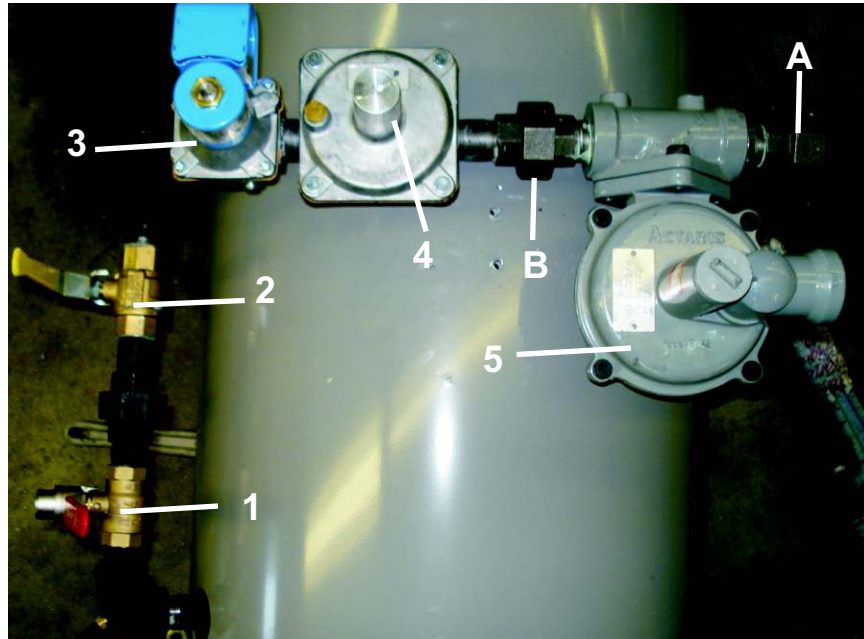

DF 1500

- | | | | | | |
|---|----------------------------|--------|---|-----------------------|--------|
| 1 | 1 1/4" conversion valve | 70271 | 4 | 1 1/4" solenoid valve | 50277B |
| 2 | 1 1/4" shut off ball valve | 70270 | 5 | 10 lbs regulator | 60275 |
| 3 | 2 stage valve | 80272A | | | |

IF GAS SUPPLY IS OVER 1/2 PSI (14" WATER COLUMN) CONNECT TO UNION A ON MANIFOLD. IF GAS PRESSURE IS 1/2PSI OR LESS, REMOVE THE 10LBS REGULATOR AND CONNECT TO UNION B.

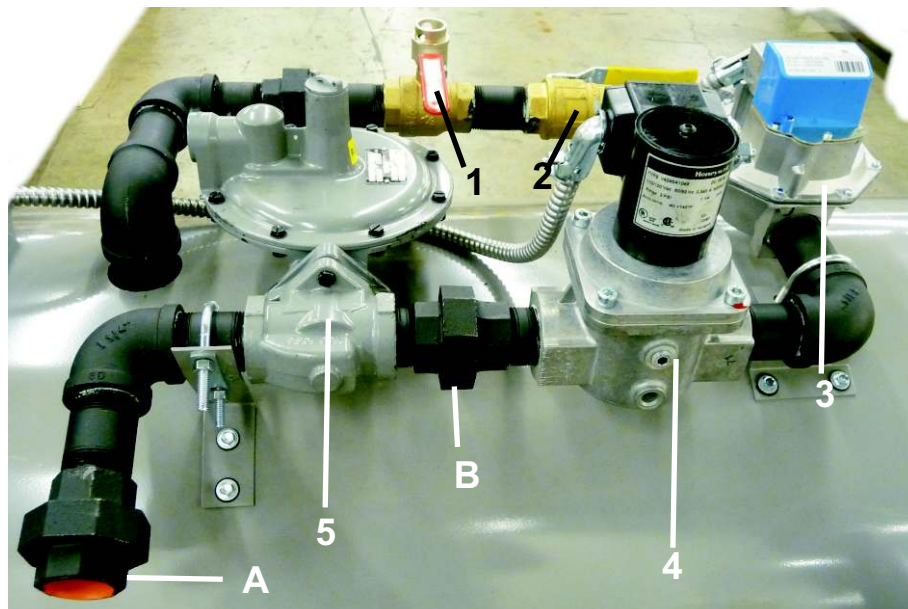

DF-1500 WIRING SCHEMATIC

20A
MALE PLUG RECEPTACLE SERVICE
115V-1Ø-60Hz

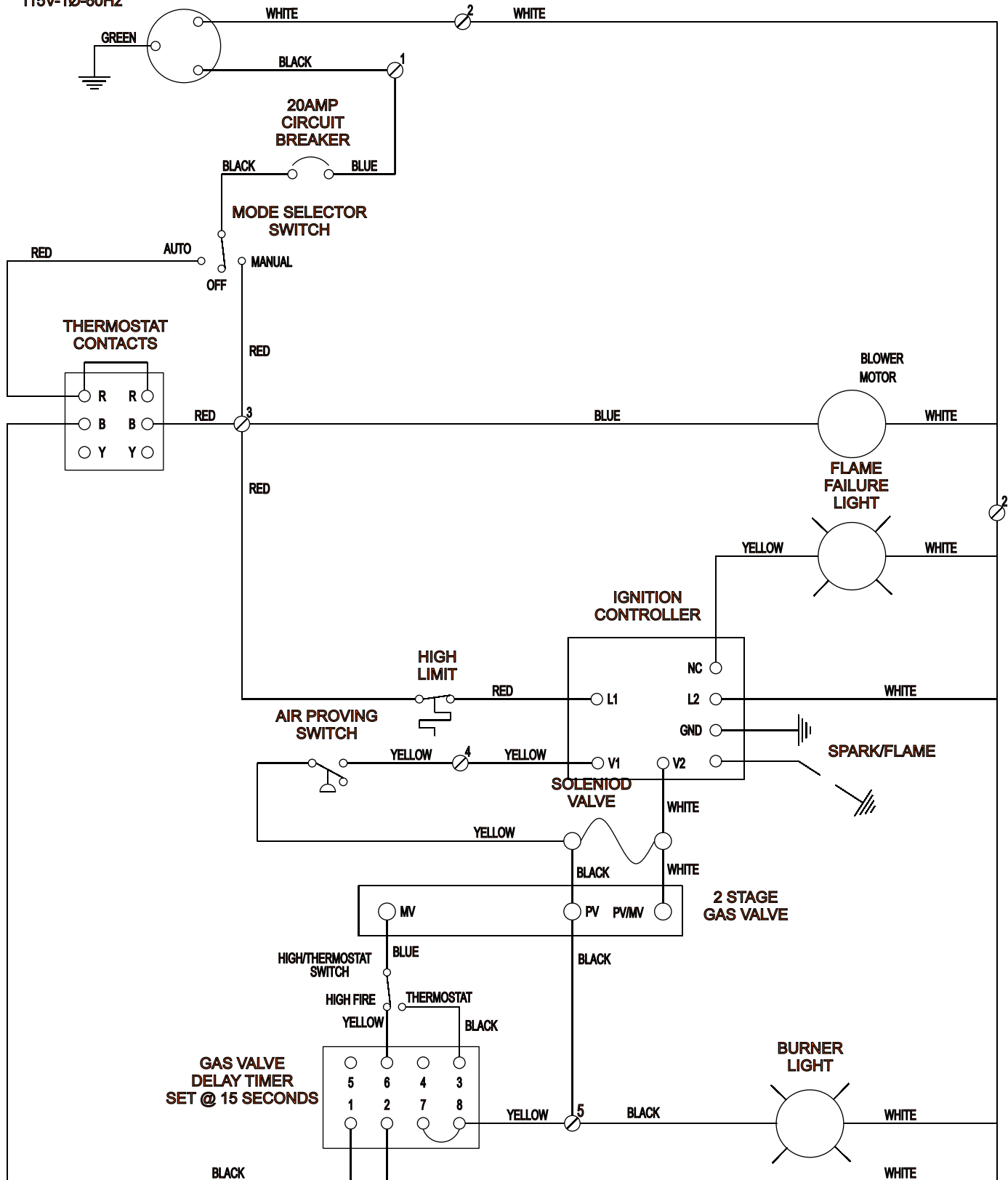

DF-400 WIRING SCHEMATIC

